

293/500

Dimensions

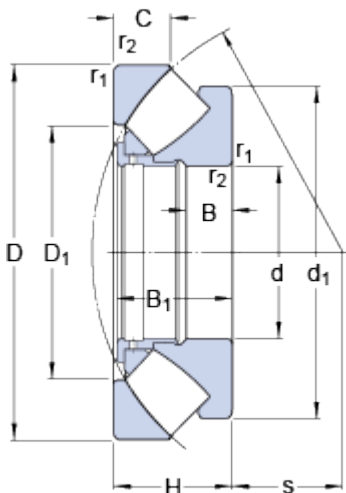

d	500	mm
D	750	mm
H	150	mm
d ₁	≈ 725	mm
D ₁	≈ 611	mm
B	50	mm
B ₁	144	mm
C	74	mm
s	280	mm
r _{1,2}	min. 6	mm

Abutment dimensions

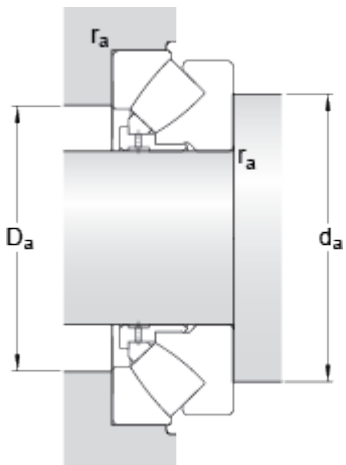

d _a	min. 630	mm
D _a	max. 675	mm
r _a	max. 5	mm

Calculation data

Basic dynamic load rating	C	4490	kN
Basic static load rating	C ₀	20400	kN
Fatigue load limit	P _u	1560	kN
Reference speed		430	r/min
Limiting speed		800	r/min
Minimum axial load factor	A	40	

Mass

Mass bearing		235	kg
--------------	--	-----	----